

TOPWET



TOPWET[®]

FLAT ROOFS
DRAINAGE SYSTEMS

CATALOGUE

Company data

TOPWET Inc.

231 S Frontage Road,
Suite 25 Burr Ridge, Illinois

GPS 41.764520, -87.940924

Customer service

Orders, inventory, invoice

Viktor Kaulich

phone: **331-258-4134**

e-mail: viktor.kaulich@topwet.com

Technical support line

email: support@topwet.com

www.topwet.com

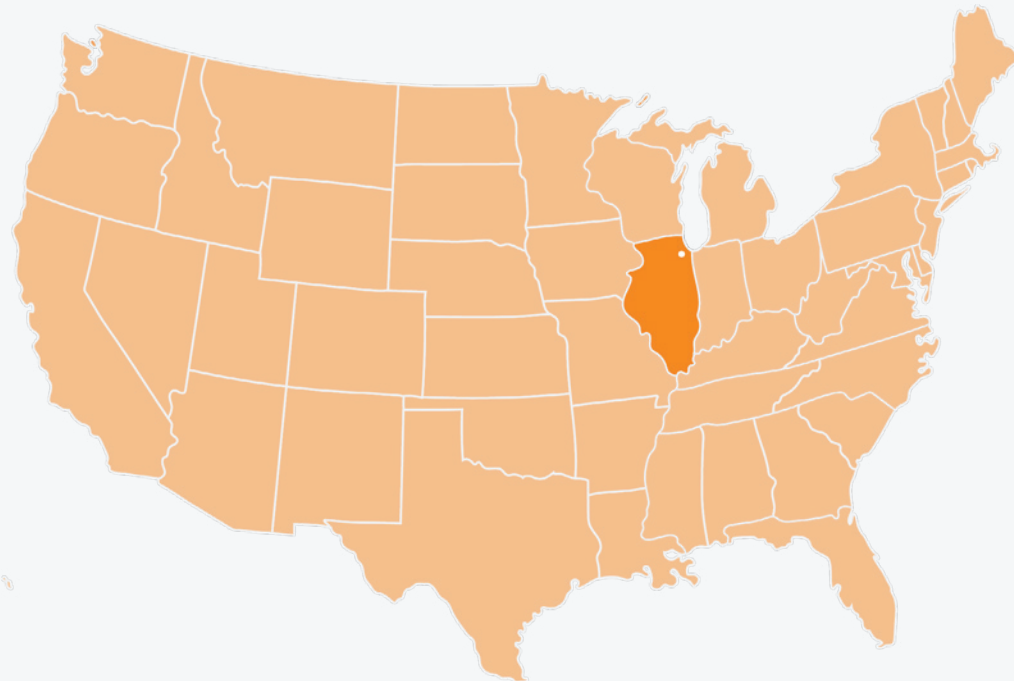

Content

Company data	2
Combination options of products and accessories	4
Self-regulating heated drains and through wall parapet drains	5
Roof Waterproofing Sleeve	6
Roof drains	8
Extenders for drains and other accessories	10
Terrace drains	12
Accessories for roof drains, terrace drains	14
Retrofit drains	16
Balcony drains and other accessories	18
Inspection chamber for green roofs	20
Through wall parapet drains and safety overflow	22

Dear business partners and valuable customers,

TOPWET s.r.o. is a Europe leading producer of roof drains and elements for flat roof.

Our company is situated in the middle of Europe – Czech Republic. This position of our company made advantage for fast supplying needed products and providing fast service to our customers in all Europe.

We are a young and ambitious team working with an open mind for innovation and the progress of our products. Cooperation with architects, roofers and plumbers, allows our team to develop TOPWET complete accessory system. TOPWET roof drains offer maximum reliability, quality and performance.







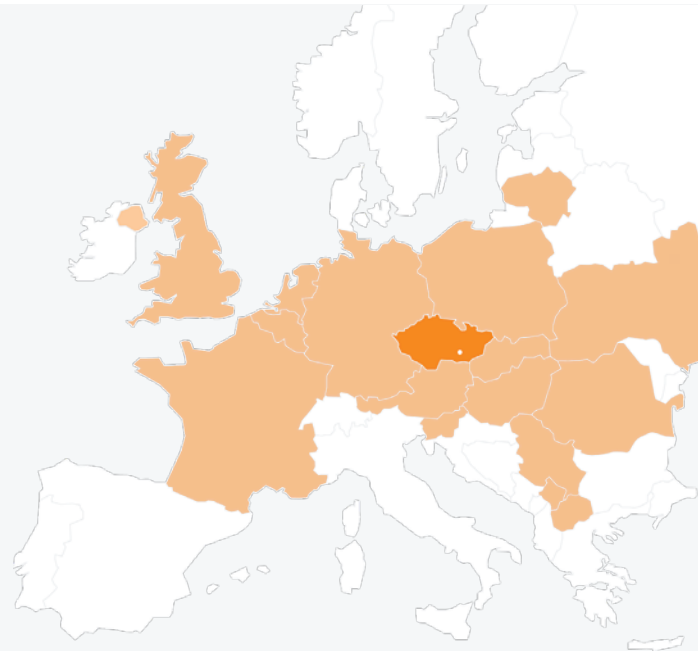



With the same values, we have established a manufacturing company TOPWET Inc strategically located in Illinois to be able fast supplying our quality products throughout the U.S.

Looking forward to a collaboration

Team TOPWET



Combination options of products and accessories

		Roof drains TW str.8	Extension units for roof drains TWN str.10	Terrace drains TWT str.12	Retrofit drains TW RETRO str.16	Balcony drains TWB str.18
TWN Extension units for roof drains		✓				
TWZU KL Mechanical stink flap		✓	✓	✓		
TWOK Perforated protective dome		✓	✓	✓	✓	
TW TER Terrace extension unit		✓	✓	✓	✓	
TW PLK Walkable protective dome		✓	✓	✓	✓	
TW ODK Drainage ring		✓	✓	✓	✓	
TWZ Shaft for green roofs		✓	✓	✓	✓	✓
TWB TER Balcony extension unit						✓
TWB ODK Drainage ring						✓
TWB PLK Walkable protective dome						✓
TWZU BAL Mechanical stink flap						✓

Self-regulating heated drains and through wall parapet drains

Flat roofs drainage

Self-regulating electric heating of drains, through wall parapet drains and retrofit drains ensures reliable drainage during the winter season. The system works by resistance change to semiconductors due to ambient temperature changes. During the winter periods drains are at risk of blocking due to ice or snow build up. The heating element is designed to protect not only the orifice of the drain but its immediate surroundings as well.

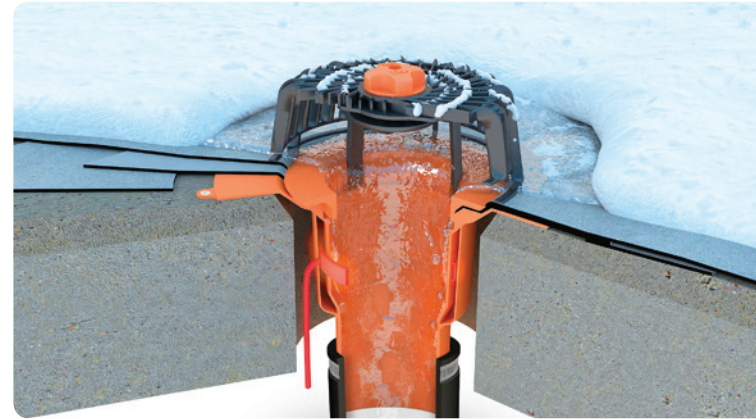

Advantages of self-regulation heating

- Reliable drainage also in winter season
- Voltage 110 V / 60Hz – without necessity of a transformer or a control unit
- Option of connection to heating of through wall parapet drains, downpipes, entries etc.
- Simple connection via a switch or a thermostat
- Electric energy saving

Connection description

- Connection is performed in an electric box under roof structure
- Length of the drain supply cable is 5'. Cable wire NM-B 14-2
- Wire connection: brown - guard, black - phase, white - neutral
- AC voltage: 110 V / 60Hz
- Input power: 10 W at 68°F / 14 W at 32°F / 20 W at -4°F
- Max. current surge: 120 mA
- Enclosure rating: IP 67

Basic options of connecting of heated drains

- Without possibility of switching off (energy consumption also in summer season – not recommended)
- Mechanical switch (manipulation required), or time socket
- Outer thermostat with integrated thermal sensor
- Thermostat to a switchboard including thermal sensor for measuring of outer temperature
- Thermostat to a switchboard including thermal and humidity sensor for measuring the outside temperature

Scheme of electrical wiring

- | | | | |
|---|--------------------|----|----------------------|
| 1 | main switch | 5 | thermostat or switch |
| 2 | current protection | L | phase (black) |
| 3 | circuit breaker | N | neutral (white) |
| 4 | drain | PE | guard (brown) |

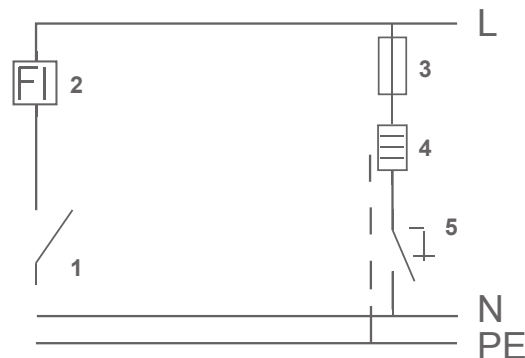

Roof Waterproofing Sleeve

TOPWET company supplies standardly all own products with integrated bitumen and TPO sleeve to ensure 100% reliable waterproof connection.

- ✓ 100% waterproof
- ✓ Without screw flanges
- ✓ Fully compatible with roof waterproofing system



Brands we cooperate with:

GAF

Elevate

Johns Manville

Carlisle

Soprema

Polyglass

Roof Waterproofing Sleeve

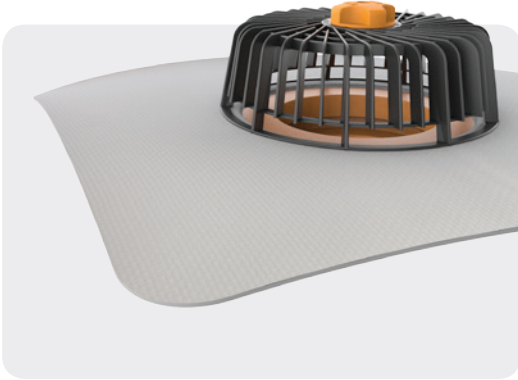

PVC

Flexible PVC. A minimum thickness of 1/16", ideally in a homogenous version, is required.

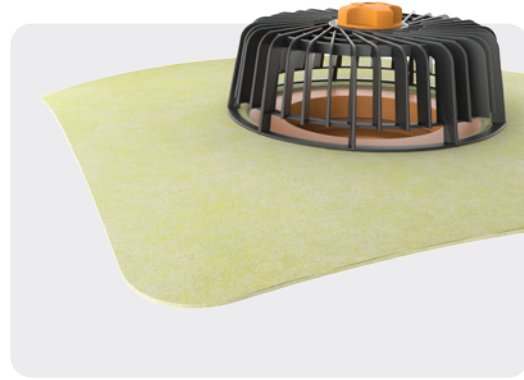

STE

A flange for connection to screed waterproofing applications. We will provide a special flexible flange with double sided integrated layer for connection to the screed waterproofing.



EPDM

A membrane of synthetic rubber. We currently manufacture with materials from the following brands: Elevate, Carlisle.

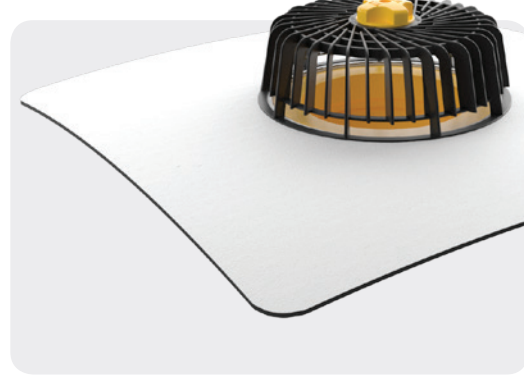

VAP

Self adhered vapour barrier comprised of SBS modified bitumen adhesive, laminated with high-density polyethylene top surface.

Roof drains

Flat roofs drainage

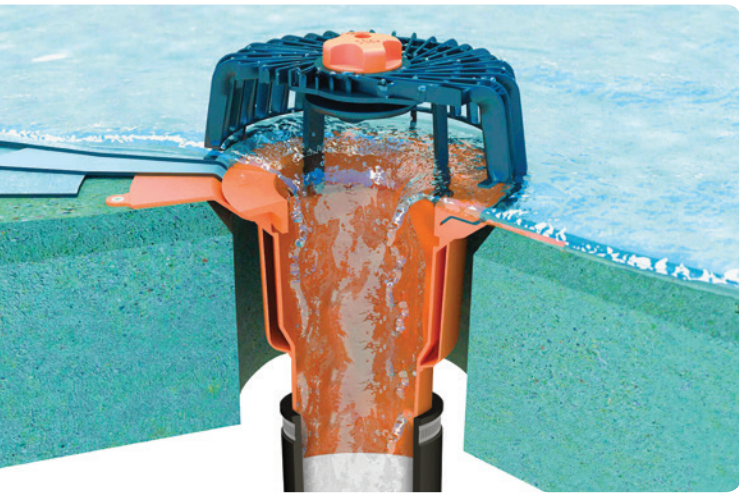

Basic Type – thermally insulated straight roof drain

- Double-wall structure of polyamide PA6
- Integrated sleeve of a waterproof membrane or vapour barrier
- Protecting dome included in each package
- Direct connection to vertical roof downpipes of DN 3", DN 4" and DN 5" diameters
- Connection to rainwater pipes of DN3", DN 4" and DN5" by flexible coupling

Complementary Type – horizontal roof drain

- Connection to rainwater pipe of DN 4" by flexible coupling
- Reduced height for warm roofs

Dimensions of straight roof drains

Type	DN	Dimensions [in]					
		a	b	c	d	e	f
TW(E) 3" S	3"	13"	8"	6"	1"	6 1/4"	8"
TW(E) 4" S	4"	13"	8"	5 1/4"	1"	6 1/4"	8"
TW(E) 5" S	5"	13"	8"	5 1/4"	1"	6 1/4"	8"

Dimensions of horizontal roof drains

Type	DN	Dimensions [in]						
		a	b	c	d	e	f	g
TW(E) 4" H	4"	13"	8"	5"	6-1/4"	11/2"	9 1/2" (10"*)	2"

* dimensions of heated version

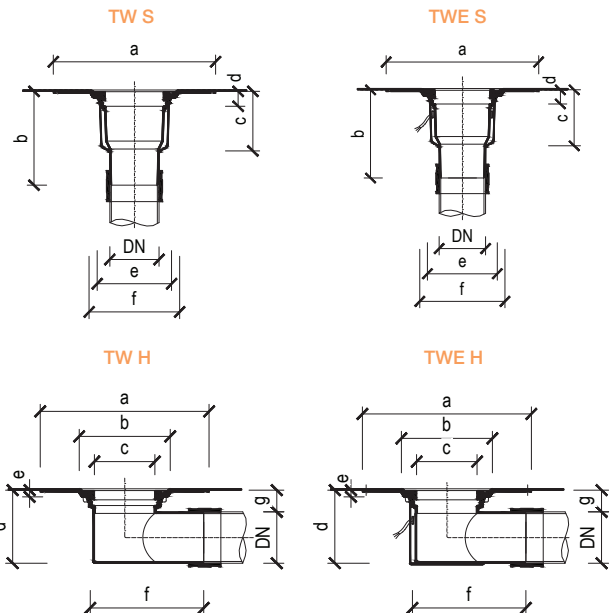

TOPWET roof drains with integrated bitumen sleeve

BIT

	Version	Type	Dimensions
	TOPWET roof drain with an integrated sleeve of modified bitumen strip, straight version, heat-insulated – double-wall with a protective dome and flexible coupling for connection to rainwater pipes.	TW 3" S BIT TW 4" S BIT TW 5" S BIT	DN 3" DN 4" DN 5"
	TOPWET roof drain with an integrated sleeve of modified bitumen strip, straight version, heat-insulated – double-wall with a protective dome and flexible coupling for connection to rainwater pipes, heated with 110 V, with a connecting cable.	TWE 3" S BIT TWE 4" S BIT TWE 5" S BIT	DN 3" DN 4" DN 5"
	TOPWET roof drain with an integrated sleeve of modified bitumen strip, horizontal version, heat-insulated – double-wall with a protective dome and flexible coupling for connection to rainwater pipes.	TW 4" H BIT	DN 4"
	TOPWET roof drain with an integrated sleeve of modified bitumen strip, horizontal version, heat-insulated – double-wall with a protective dome and flexible coupling for connection to rainwater pipes, heated with 110 V, with a connecting cable.	TWE 4" H BIT	DN 4"

Option to supply with custom made sleeve (PVC, EPDM, VAP, STE – suitable for screed waterproofing). For more information please see page 7.

TOPWET roof drains with integrated TPO sleeve

TPO

	Version	Type	Dimensions
	TOPWET roof drain with an integrated sleeve of a waterproofing membrane based on TPO, straight version, heat-insulated – double-wall with a protective dome and flexible coupling for connection to rainwater pipes.	TW 3" S TPO TW 4" S TPO TW 5" S TPO	DN 3" DN 4" DN 5"
	TOPWET roof drain with an integrated sleeve of a waterproofing membrane based on TPO, straight version, heat-insulated – double-wall with a protective dome and flexible coupling for connection to rainwater pipes, heated with 110 V, with a connecting cable.	TWE 3" S TPO TWE 4" S TPO TWE 5" S TPO	DN 3" DN 4" DN 5"
	TOPWET roof drain with an integrated sleeve of a waterproofing membrane based on TPO horizontal version, heat-insulated – double-wall with a protective dome and flexible coupling for connection to rainwater pipes.	TW 4" H TPO	DN 4"
	TOPWET roof drain with an integrated sleeve of a waterproofing membrane based on TPO, horizontal version, heat-insulated – double-wall with a protective dome and flexible coupling for connection to rainwater pipes, heated with 110 V, with a connecting cable	TWE 4" H TPO	DN 4"

Option to supply with custom made sleeve (PVC, EPDM, VAP, STE – suitable for screed waterproofing). For more information please see page 7.

Extenders for drains and other accessories

Drainage of warm roofs



Basic Type – universal accessories



- Applicable for roof drains of DN 3", DN 4" diameters, drains vertical and horizontal including heated ones
- Height depending on a insulated thickness ranging from 1 1/2"
- Sealing ring protecting against raised water included

Dimensions of the extenders for roof drains

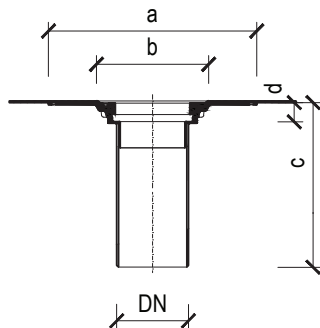
Type	for roof drains TW / TWE	Dimensions [in]				
		a	b	c	d	Insulation Thickness
TWN H6"	3", 4"	13"	8"	11"	1 1/2"	2" – 9"
TWN H12"	3", 4"	13"	8"	14"	1 1/2"	2" – 12"

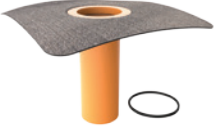

Extenders for thermal insulation for TOPWET roof drains

	Version	Type	Insulation Thickness
	TOPWET extenders with an integrated sleeve of modified bitumen strip for straight a horizontal roof drains of DN 3" a and 4", with a sealing ring, without a dome.	TWN H6" BIT TWN H12" BIT	2" – 9" 2" – 12"
	TOPWET extenders with an integrated sleeve of a waterproofing membrane based on TPO for straight a horizontal roof drains of DN 3" a and 4", with a sealing ring, without a dome	TWN H6" TPO TWN H12" TPO	2" – 9" 2" – 12"

Option to supply with custom made sleeve (PVC, EPDM, VAP, STE – suitable for screed waterproofing). For more information please see page 7.

Retrofit seal

Accessories



Version	Type	Outer / inner diameter
Two-stage retrofit seal TOPWET for connecting the second stage to retrofit drains. Can be combined with diameters DN 2"- DN 5".	TWN SAN TES	5" / 4"

Heating kit

Accessories



Version	Type	Dimensions
Kit includes a self regulating AC 110V, 60Hz heat cable (cable heat section 1' long inlet cable length 5'). Complete with two plastic mounting straps to fix the cable to the pipe	TW SE	

Terrace drains

Flat roofs, terraces and balconies drainage

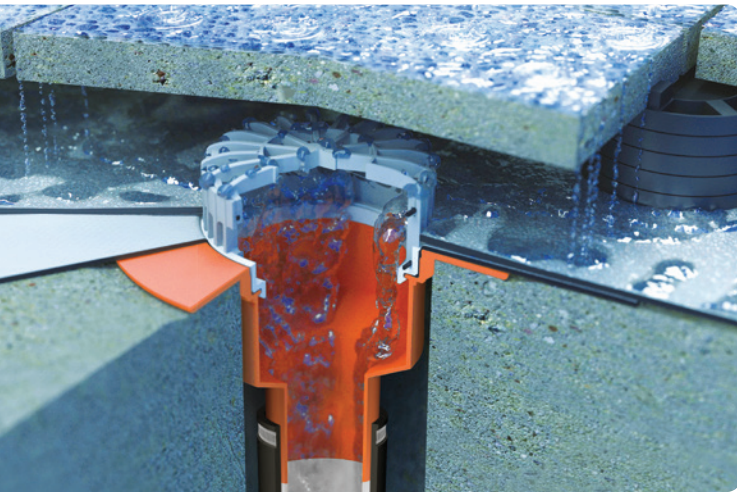

- Straight version 3" and 4", horizontal version 4"
- Higher drainage capacity
- Construction from polyamide PA6
- Integrated sleeve of a waterproof membrane
- Low construction height
- A special low dome is part of every drain, with possibility of adjustment to a flat leaf guard
- A heated version will ensure reliable drainage even in the winter season

Terrace drains – straight version

Type	DN	Dimensions [in]						
		a	b	c	d	e	f	g
TWT(E) 3" S	3"	8"	7"	3"	3" (*2")	1" (*2")	5"	6"
TWT(E) 4" S	4"	8"	7"	3"	3" (*2")	1" (*2")	5"	6"

* dimension at heated version

Terrace drains – horizontal version

Type	DN	Dimensions [in]			
		a	b	c	d
TWT(E) 4" H	4"	8"	5 1/2"	9 1/2"	1 1/4"

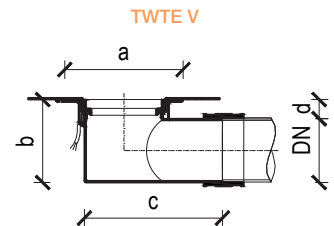
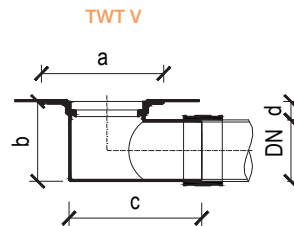
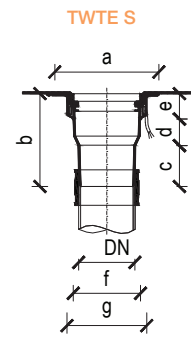
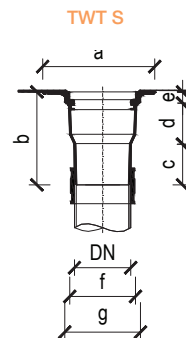

TOPWET terrace drain with an integrated bitumen sleeve

BIT



Version	Type	Dimensions
TOPWET terrace drain with an integrated sleeve of modified bitumen strip, straight version with a protective dome and flexible coupling for connection to rainwater pipes.	TWT 3" S BIT TWT 4" S BIT	3" 4"
TOPWET terrace drain with an integrated sleeve of modified bitumen strip, straight version with a protective dome and flexible coupling for connection to rainwater pipes, heated with 110 V, with a connecting cable.	TWTE 3" S BIT TWTE 4" S BIT	3" 4"
TOPWET terrace drain with an integrated sleeve of modified bitumen strip, horizontal version with a protective dome and flexible coupling for connection to rainwater pipes.	TWT 4" H BIT	4"
TOPWET terrace drain with an integrated sleeve of modified bitumen strip, horizontal version with a protective dome and flexible coupling for connection to rainwater pipes, heated with 110 V, with a connecting cable.	TWTE 4" H BIT	4"

Option to supply with custom made sleeve (PVC, EPDM, VAP, STE – suitable for screed waterproofing). For more information please see page 7.

TOPWET terrace drains with an integrated TPO sleeve

TPO



Version	Type	Dimensions
TOPWET terrace drain with an integrated sleeve of a waterproofing membrane based on TPO, straight version with a protective dome and flexible coupling for connection to rainwater pipes	TWT 3" S TPO TWT 4" S TPO	3" 4"
TOPWET terrace drain with an integrated sleeve of a waterproofing membrane based on TPO, straight version with a protective dome and flexible coupling for connection to rainwater pipes, heated with 110 V, with a connecting cable	TWTE 3" S TPO TWTE 4" S TPO	3" 4"
TOPWET terrace drain with an integrated sleeve of a waterproofing membrane based on TPO horizontal version with a protective dome and flexible coupling for connection to rainwater pipes	TWT 4" H TPO	4"
TOPWET terrace drain with an integrated sleeve of a waterproofing membrane based on TPO, horizontal version with a protective dome and flexible coupling for connection to rainwater pipes, heated with 110 V, with a connecting cable.	TWTE 4" H TPO	4"

Option to supply with custom made sleeve (PVC, EPDM, VAP, STE – suitable for screed waterproofing). For more information please see page 7.

Accessories for roof drains, terrace drains and extenders

Drainage of ballast roofs, terraces and anti-stink measures

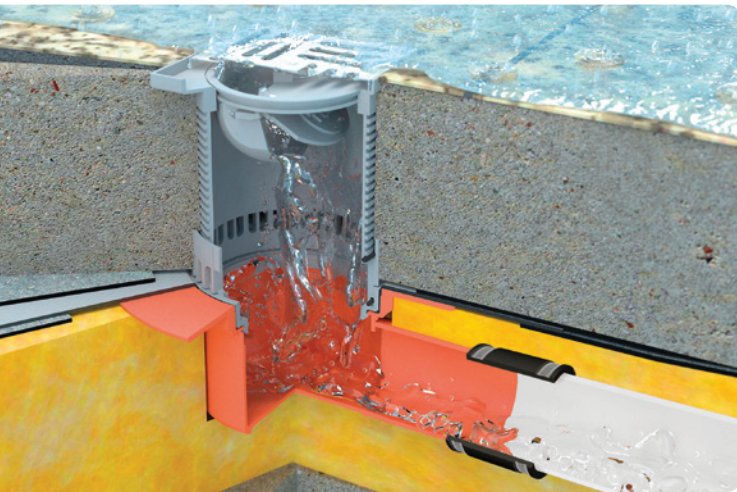

Accessories for roof drains, terrace drains and extenders

- On roofs with a ballast layer of gravel it is necessary to use a perforated protective dome
- Wide range of accessories for walkable roofs
- Terrace extension units for drainage from the paving surface level
- Possibility of using a odour trap inserted in the drain

Leaf guard for roofs with gravel

Type	DN	Dimensions [in]		Purpose
		a		
TWOK H1,3"	5" *	4"		A universal dome for roof drains 3", 4", terrace drains 3" and 4", extenders for drains and retrofit drains.
TWOK H2,6"	5" *	4"		
TWOK H3,9"	5" *	4"		
TWOK H5,2"	5" *	5 1/3"		
TWOK H6,5"	5" *	6 2/3"		
TWOK H7,9"	5" *	8"		

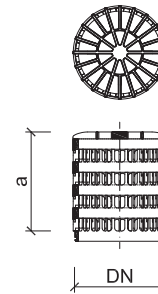

* How can extension units be universal for various diameters of roof and terrace drains 3" and 4"?

The drains have a neck or an integrated flange of the same construction and diameter. The drain construction only differs below the neck. Ensuring that all the accessories are universal.

Terrace extension units

Type	DN	Dimensions [in]			Purpose
		a	b	c	
TW TER	5" *	4"	5 1/2"	1 1/2"	A universal terrace extension units for roof drains 3", 4", terrace drains 3", 4", extension units for drains, retrofit drain and extenders.
TW TER P	5" *	8 2/3"	5 1/2"	1 1/2"	

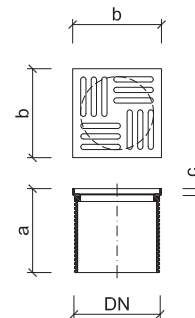

What extension unit shall I use if I have screed waterproof which is at the level of the drain neck?

For this Type of finish, there is TW TER extension unit which can be shortened according to the height of the screed and paving.

Mechanical roof flaps into TOPWET roof drains, terrace drains and extenders

Accessories



Version	Type	Height
Mechanical stink flap TOPWET with increased drainage capacity and self-cleaning properties. It is designed for roof drains and extension units. The flap should not be installed in an environment with the inhibited air circulation.	TWZU KL	

Accessories for roof drains, terrace drains and roof drains extenders

Accessories



Version	Type	Height above insulation level
Terraced extension units TOPWET for balconies and terraces with glued or otherwise mounted pavement. The package includes one drainage ring for the more continuous water runoff from the main waterproof system. The terraced extension units can be extended with another drainage ring TW ODK by about 1 1/3" or the extension units TWN TER. The extension units height is adjustable; the thick-walled polyamide PA6 UV Stabil design.	TW TER	+1/2" – 4" (2" – 6")*



Perforated terraced extension units TOPWET for balconies and terraces with the pavement. The package includes three drainage rings for smoother water runoff from the main waterproof system. The terraced extension units can be extended with another drainage ring TW ODK by about 1 1/3" or the extension units TWN TER. The extension units height is adjustable; the thick-walled polyamide PA6 UV Stabil design.	TW TER P	2" – 8 2/3"
---	----------	-------------



Maximal height of the extension unit for an extension of the terrace extension unit TW TER can be 5". The exact height of the extension units can always be adapted directly on site. The thick-walled polyamide PA6 UV Stabil design.	TWN TER	1/2" – 5"
--	---------	-----------



Drainage ring TOPWET. The thick-walled polyamide PA6 UV Stabil design. The height above the level of the waterproof system is 1 1/3". The hole size of 1/2" x 1/4".	TW ODK	+1 1/3"
---	--------	---------



Flat walkable protective dome TOPWET. The thick-walled polyamide PA6 UV Stabil design. The height above the level of the waterproof system is 1/2".	TW PLK	+1/2"
---	--------	-------



Perforated protective dome TOPWET for roofs with gravel or other load-increasing strata. The dome can be extended with the drainage ring TW ODK always by 1 1/3". The thick-walled polyamide PA6 UV Stabil design.	TWOK H1,3"	1 1/2"
	TWOK H2,6"	2 2/3"
	TWOK H3,9"	4"
	TWOK H5,2"	5 1/3"
	TWOK H6,5"	6 2/3"
	TWOK H7,9"	8"

* The heights apply when the TW ODK

Retrofit drains

Flat roof retrofit drains

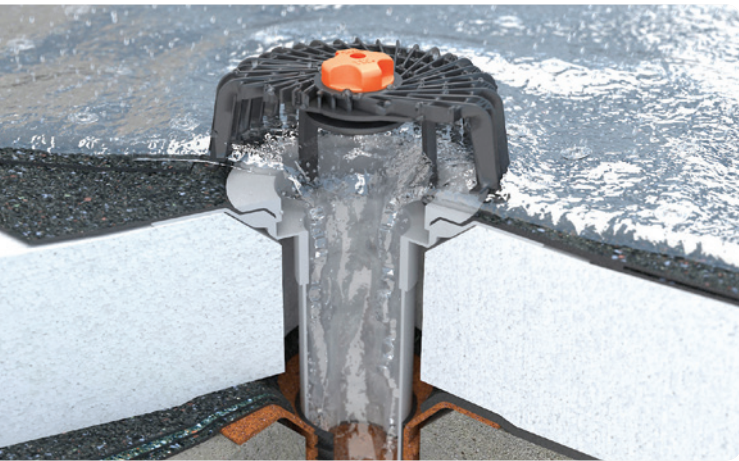

- Direct connection to existing roof drains or vertical rainwater pipes
- Wide assortment of fine graduated diameters
- Easy application with refurbishment with use of a new heat-insulated layer from a thickness of 2"
- Custom manufacturing of higher retrofit drains with a tube of a length up to 60"
- Lip seal against raised water included in each drain
- Assembly lubricant included in each package
- Heated version on request

Refurbishment drains for warm roofs

Type	Dimensions [in]				
	a	b	c**	d	e
TW RETRO 3"	13"	8"	16"	1 1/2" (3 1/2")*	3 1/2"
TW RETRO 4"	13"	8"	16"	1 1/2" (3 1/2")*	3 1/2"
TW RETRO 5"	13"	8"	16"	1 1/2" (3 1/2")*	3 1/2"
TW RETRO 6"	13"	8"	16"	1 1/2" (3 1/2")*	3 1/2"

* dimension at heated version

** optionally extension up to 60" to order

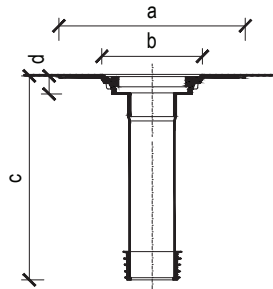



Selection table for retrofit drains

Type	For connection to piping of diameter	Type of existing downpipe [DN]																							
		Cast iron								PE								RPVC				PP			
		2 3/4"	3 1/4"	4"	4 1/4"	5"	6"	8"	2 1/4"	3"	3 1/2"	4 1/4"	5"	6"	8"	2 3/4"	4"	5"	6"	8"	4"	5"	6"	8"	
TW RETRO 3"	3" - 4"		✓								✓													✓	
TW RETRO 4"	4" - 4 1/4"			✓							✓						✓							✓	
TW RETRO 5"	4 1/2" - 5"					✓								✓				✓						✓	
TW RETRO 6"	5 3/4" - 6"						✓								✓				✓					✓	

TOPWET retrofit drains with integrated bitumen sleeve



BIT

	Version	Type	For connection to piping of diameter
	<p>TOPWET retrofit drain with an integrated sleeve of modified bitumen strip with a protective dome. Length 16" option of extension up to 60" on request.</p>	<p>TW RETRO 3" BIT TW RETRO 4" BIT TW RETRO 5" BIT TW RETRO 6" BIT</p>	<p>3" – 4" 4" – 4 1/4" 4 1/2" – 5" 5 3/4" – 6"</p>
	<p>TOPWET retrofit drain with an integrated sleeve of modified bitumen strip with a protective dome, heated with 110 V, with a connecting cable. Length 16" option of extension up to 60" on request.</p>	<p>TW RETRO 3" BIT TW RETRO 4" BIT TW RETRO 5" BIT TW RETRO 6" BIT</p>	<p>3" – 4" 4" – 4 1/4" 4 1/2" – 5" 5 3/4" – 6"</p>

Option to supply with custom made sleeve (PVC, EPDM, VAP, STE – suitable for screed waterproofing). For more information please see page 7.

TOPWET retrofit drains with integrated TPO sleeve

TPO

	Version	Type	For connection to piping of diameter
	<p>TOPWET retrofit drain with an integrated sleeve of a waterproofing membrane based on TPO with a protective dome. Length 16" option of extension up to 60" on request.</p>	<p>TW RETRO 3" TPO TW RETRO 4" TPO TW RETRO 5" TPO TW RETRO 6" TPO</p>	<p>3" – 4" 4" – 4 1/4" 4 1/2" – 5" 5 3/4" – 6"</p>
	<p>TOPWET retrofit drain with an integrated sleeve of a waterproofing membrane based on TPO with a protective dome, heated with 110 V, with a connecting cable. Length 16" option of extension up to 60" on request.</p>	<p>TWE RETRO 3" TPO TWE RETRO 4" TPO TWE RETRO 5" TPO TWE RETRO 6" TPO</p>	<p>3" – 4" 4" – 4 1/4" 4 1/2" – 5" 5 3/4" – 6"</p>

Option to supply with custom made sleeve (PVC, EPDM, VAP, STE – suitable for screed waterproofing). For more information please see page 7.

Balcony drains and other accessories

Drainage of balconies

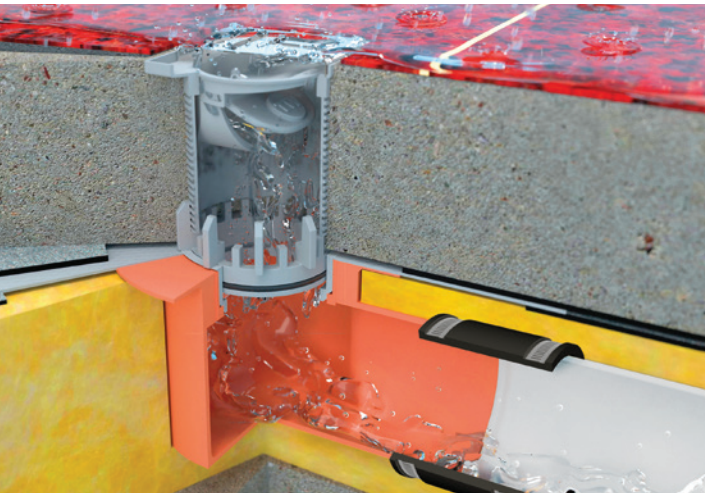

- 2" and 3" straight version
- PA6 polyamide construction
- Integrated sleeve of a waterproof membrane
- Small dimensions
- Suitable to drain smaller areas
- Protective and removable grid included in each drain
- Heated version ensures reliable drainage even in winter season

Balcony drains – straight version

Type	DN	Dimensions [in]							
		a	b	c	d	e	f	g	h
TWB 2" S	2"	6"	5"	2"	2"	1"	4"	-	-
TWB 3" S	3"	6"	5"	2"	2"	1"	4"	-	-
TWBE 2" S	2"	6"	5"	2"	-	-	5"	1 1/4"	1 3/4"
TWBE 3" S	3"	6"	5"	2"	-	-	5"	1 1/4"	1 3/4"

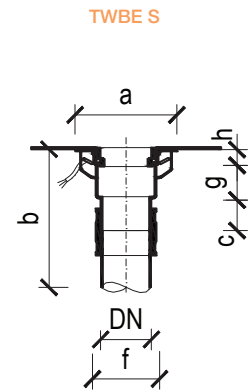
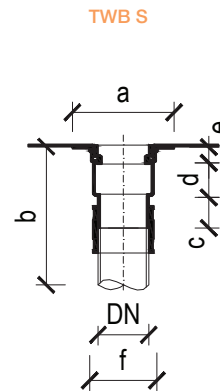

TOPWET balcony drains with integrated bitumen sleeve

BIT

	Version	Type	Dimensions
	TOPWET balcony drain with an integrated sleeve of modified bitumen strip, straight version with a protective flat leaf guard.	TWB 2" S BIT TWB 3" S BIT	2" 3"
	TOPWET balcony drain with an integrated sleeve of modified bitumen strip, straight version, heated with 110 V with a supply cable, with a protective flat leaf guard.	TWBE 2" S BIT TWBE 3" S BIT	2" 3"





Option to supply with custom made sleeve (PVC, EPDM, VAP, STE – suitable for screed waterproofing). For more information please see page 7.

TPO

	Version	Type	Dimensions
	TOPWET balcony drain with integrated sleeve of a waterproofing membrane based on TPO, straight version with a protective flat leaf guard.	TWB 2" S TPO TWB 3" S TPO	2" 3"
	TOPWET balcony drain with integrated sleeve of a waterproofing membrane based on TPO, straight version, heated with 110 V with a supply cable, with a protective flat leaf guard.	TWBE 2" S TPO TWBE 3" S TPO	2" 3"

Option to supply with custom made sleeve (PVC, EPDM, VAP, STE – suitable for screed waterproofing). For more information please see page 7.

Accessories for TOPWET balcony drains

	Version	Type	Height above insulation level
	TOPWET balcony extension unit of a new generation with a stainless steel grid 4" x 4". For balconies with glued or differently laid tiles. The balcony extension unit can be extended using another TWB ODK drainage ring of 1". The package includes drainage ring for the more continuous water runoff from main waterproof system. The exact height of the extension unit can always be adapted directly on site. The thick-walled polyamide PA6 UV Stabil design.	TWB TER	1/2" - 4" (2" - 5")*
	Balcony drainage ring for extension of the TWB TER balcony extension unit, always by 1". The thick-walled polyamide PA6 UV Stabil design. The hole size of 1/2"x1/4" mm.	TWB ODK	1"
	Flat walkable protective dome for balcony drains. The thick-walled polyamide PA6 UV Stabil design. The height above the level of the waterproof system is 1/2".	TWB PLK	1/2"
	Mechanical stink flap for vertical version of balcony drains.	TWZU BAL	

* The heights apply when the TW ODK BAL item is used

Inspection chamber for green roofs

Accessories for roofs with vegetation layers



- Dimension 16"x16"
- Variable height adjustment - basic set of 4"
- New design, stronger construction, finer perforations, fluent drainage of water from the vegetation
- Removable grid in neutral gray
- Solid, UV stable material
- Easy to check and roof drain maintenance

Inspection chamber for green roofs

Type	Dimensions [in]			
	a	b	c	d
TWZ 16"/16"/5"	16"	5"	4"	1"
TWZN H4" 16"/16"	16"	5"	4"	1"

TWZ

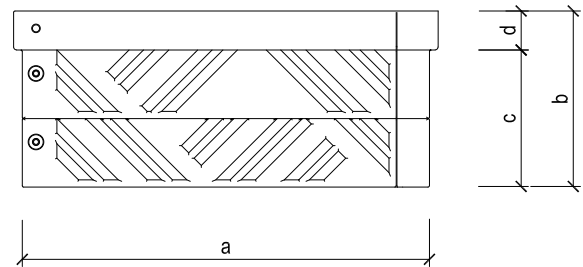



Self - assembly

Design of chambers for green roof is structurally adapted, so that the chambers can be assembled in required height self-help directly on construction.

Using height slats and fasteners to the cover grid TWZ or TWZF can be easy to assemble the whole protective chamber to the required height according to vegetation formation.

Inspection chamber for green roofs

	Version	Type	Dimensions
	<p>Inspection chamber for green roofs, height 5", including perforated plastic cover grid.</p>	<p>TWZ 16"/16"/5"</p>	<p>16" x 16"</p>
	<p>Basic set of four slats for an increase of 4", fasteners are included.</p>	<p>TWZN H4" 16"/16"</p>	<p>16" x 16"</p>

Chamber components with perforated grid,
height 17"

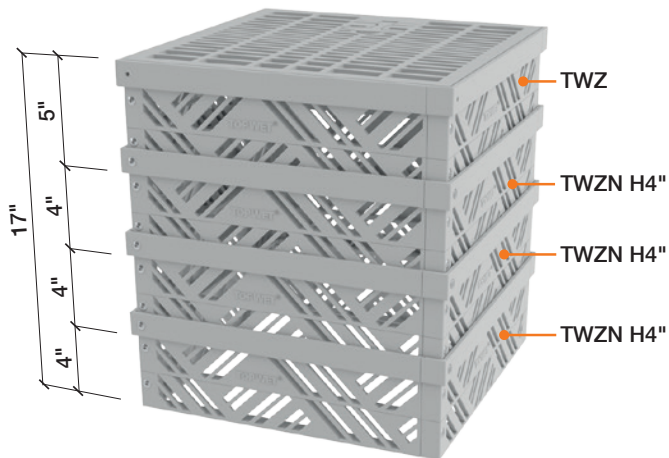

Chamber components with perforated grid,
height 9"

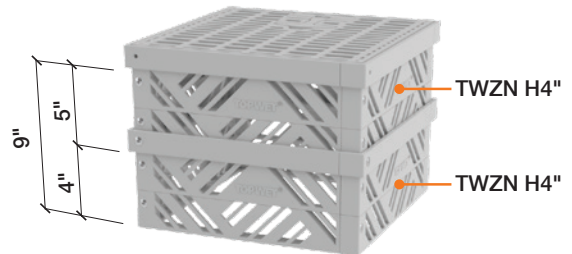

Through wall parapet drains and safety overflows

Drainage of flat roofs, terraces and balconies



Basic Type – round through wall parapet drain of 24" length

- Integrated sleeve of waterproofing membrane
- Protective and removable grid included in each through wall parapet drain
- Possibility to extend up to 60"
- Through wall parapet drain made of UV stable PVC
- Heated version ensures reliable drainage even in winter season
- Possibility of connection to a rain hopper or to downpipes DN 4", 5" and DN 6"

Round overflow drain of 24" length

- Made of UV stable PVC
- Integrated sleeve of waterproofing membrane
- Produced at 3", 4" and 5", possibility to extend up to 60"
- Recommended overlap over the facade is at least 4"

Through wall drains – round

Type	DN	Dimensions [in]							
		a	b	c	d	e	f	g	h
TWC(E) 4"	4"	24"	1"	7"	6"	1/2"	2 1/2"	1"	2 1/2"
TWC(E) 5"	5"	24"	1"	7"	6"	1/2"	2 1/2"	1"	2 1/2"
TWC(E) 6"	6"	24"	1"	7"	6"	1/2"	2 1/2"	1"	2 1/2"

Safety overflows - round

Type	DN	Dimensions [in]				
		a*	b	c	d	e
TWPP 3"	3"	24"	1/2"	3"	1"	3"
TWPP 4"	4"	24"	1/2"	4 1/2"	1"	2 1/2"
TWPP 5"	5"	24"	1/2"	5"	1"	2 1/2"

* can be extended up to 6'6" on request (it is charged)

TWC

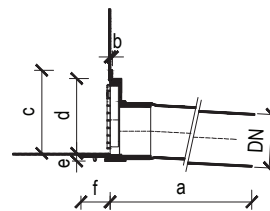

TWCE

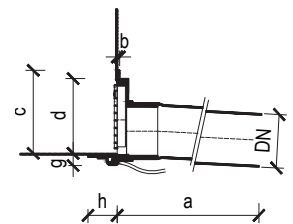

TWPP

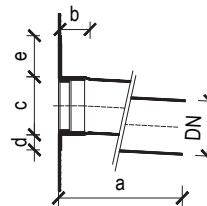

TOPWET through wall parapet drains and safety overflows with integrated bitumen sleeve

BIT

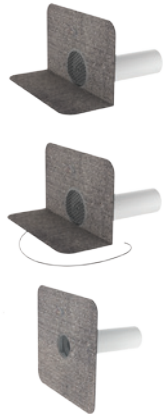

Version	Type	Dimensions
TOPWET round through wall parapet drain with an integrated sleeve of modified bitumen strip and with a leaf guard. Length 24", option of extension up to 60" on request.	TWC 4" BIT TWC 5" BIT TWC 6" BIT	4" 5" 6"
TOPWET round through wall parapet drain with an integrated sleeve of modified bitumen strip and with a leaf guard, heated with 110 V with a supply cable. Length 24", option of extension up to 60" on request.	TWCE 4" BIT TWCE 5" BIT TWCE 6" BIT	4" 5" 6"
TOPWET round safety overflow with an integrated sleeve of modified bitumen strip. Length 24", option of extension up to 60" on request.	TWPP 3" BIT TWPP 4" BIT TWPP 5" BIT	3" 4" 5"

Option to supply with custom made sleeve (PVC, EPDM, VAP, STE – suitable for screed waterproofing). For more information please see page 7.

TOPWET through wall parapet drains and safety overflows with integrated TPO sleeve

TPO



Version	Type	Dimensions
TOPWET round through wall parapet drain with an integrated sleeve of a waterproofing membrane based on TPO and with a leaf guard. Length 24", option of extension up to 60" on request.	TWC 4" TPO TWC 5" TPO TWC 6" TPO	4" 5" 6"
TOPWET round through wall parapet drain with an integrated sleeve of a waterproofing membrane based on TPO and with a leaf guard, heated with 110 V with a supply cable. Length 24", option of extension up to 60" on request.	TWCE 4" TPO TWCE 5" TPO TWCE 6" TPO	4" 5" 6"
TOPWET round safety overflow with an integrated sleeve of a waterproofing membrane based on TPO. Length 24", option of extension up to 60" on request.	TWPP 3" TPO TWPP 4" TPO TWPP 5" TPO	3" 4" 5"

Option to supply with custom made sleeve (PVC, EPDM, VAP, STE – suitable for screed waterproofing). For more information please see page 7.

TOPWET



TOPWET Inc.

231 S Frontage Road, Suite 25 | Burr Ridge, IL 60527

www.topwet.com



TOPWET[®]
SYSTÉMY ODVODNĚNÍ
PLOCHÝCH STŘECH

TOPSAFE[®]
FALL PROTECTION
SAFETY SYSTEMS

TOPSET[®]
WINDOW
SILLS

TOPSTEP[®]
STAIRCASE
SYSTEM

CEMVIN[®]
CEMENT-FIBROUS
BOARDS